



UNIVERSAL SALES

irripod

FLEXIBLE IRRIGATION

Catalog ~ Price list

Effective: 3-1-2017



UNIVERSAL SALES

92311 Booth Street
Junction City, OR 97448
www.universalsales.biz

Phone : 541-998-9999

Fax : 541-998-9998

Toll Free Fax : 888-998-7998

Email : Universal@UniversalSales.biz



Irripod Component System

Pods are sold "a la carte" so that the appropriate saddles and fittings can be purchased for each project, lowering the initial installation cost:

Component A = Pods

Component B = Tapping Saddle Tops

Component C = Risers & Regulators

Component D = Sprinklers & Rotators

Component E = Tube & Fittings

"Ranch pack" kits are also available that include all the parts needed.

Irripod Catalog Table of Contents

Ranch Packs	Page 3
Component A = Pods	Page 4
Component B = Tapping Saddle Tops	Page 5-6
Component C = Risers and Regulators	Page 7
Component D = Sprinklers and Rotators	Page 8-9
Component E = Tube and Fittings	Page 10-13
Parts	Page 14-15
Hitch Mount Tube Dispenser	Page 16
Tow Trailer	Page 17
Friction Loss Charts	Page 18
Sprinkler and Rotator Performance Charts	Page 19
Terms and Conditions	Page 20



UNIVERSAL SALES ~ Irripod

Ranch Pack - 5 Pod 2 Acre Kit

The 5 pod Ranch Pack is ideal for about 2 acres of pasture.
(200'x400' maximum)

Included are 300' of 1.5" Irripod tube, 5 pods, 5 saddles, 5 sprinklers with 3 sets of nozzles, and all the fittings required. All that is needed is a 1.5" MPT water supply connection at the center of the area to be irrigated.

Ranch Pack - 8 Pod 3 Acre Kit

The 5 pod Ranch Pack is ideal for about 3 acres of pasture.
(200'x725' maximum)

Included are 450' of 1.5" Irripod tube, 8 pods, 8 saddles, 8 sprinklers with 3 sets of nozzles, and all the fittings required. All that is needed is a 1.5" MPT water supply connection at the center of the area to be irrigated.

PART #	LIST	DESCRIPTION
--------	------	-------------

IP RP5	1,239.30	5 POD RANCH PACK
IP RP8	1,880.10	8 POD RANCH PACK



See the Ranch Pack brochures for more information and pictures:
www.universalsales.biz

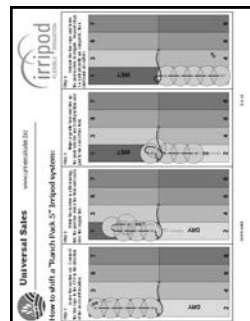

UNIVERSAL SALES ~ Irripod

Component A = Pods

IRRIPOD PODS

PART # LIST DESCRIPTION

IP 1.75 POD 112.00 POD FOR 1.5" & 1.75" IRRIPOD TUBE
(7 PER BOX)

EACH POD COMES WITH:



1 = IP DOME W (white dome) call for other colors



1 = IP BASE (black base)



1 = IP WIRE (wire guard)



2 = IP WIRE CLIP (plastic clip for wire guard)



1 = IP TST O-RING (O-Ring for Irripod saddles)



1 = IP 1.75 CTA (cross tee anchor for 1.5" & 1.75" Irripod tube)

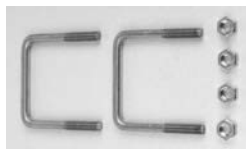

1 = IP UBOLTS (set of u bolts and nuts for cross tee anchor)



1 = IP SCREWS (set of screws for pod dome & wire clips)





UNIVERSAL SALES ~ Irripod

Component B = Tapping Saddle Tops

	PART #	LIST	DESCRIPTION
--	--------	------	-------------

1.5"	acme 	IP TST 1.5-A	8.00	1.5" saddle x R2000 Acme thread
------	---	--------------	------	---------------------------------

1.5"	1/2" 	IP TST 1.5-1/2	8.00	1.5" saddle x 1/2" FPT high riser
------	---	----------------	------	-----------------------------------

1.5"	3/4" 	IP TST 1.5-3/4	13.40	1.5" saddle x 3/4" MPT comes with 1 = 3/4" FPT Coupler
------	--	----------------	-------	---

1.75"	1/2" 	IP TST 1.75-LOW	8.00	1.75" saddle x 1/2" FPT low riser
-------	---	-----------------	------	-----------------------------------

1.75"	1/2" 	IP TST 1.75-1/2	8.00	1.75" saddle x 1/2" FPT high riser
-------	---	-----------------	------	------------------------------------

1.75"	3/4" 	IP TST 1.75-3/4	13.40	1.75" saddle x 3/4" MPT comes with 1 = 3/4" FPT Coupler
-------	---	-----------------	-------	--



UNIVERSAL SALES ~ Irripod

Component B = Tapping Saddle Tops (continued)

	PART #	LIST	DESCRIPTION
IRRIPOD 1.5" POP UP KIT			



IP TST 1.5-POP

42.00

POP UP KIT FOR 1.5" IRRIPOD

(USE WITH NELSON R2000WF = SOLD SEPARATELY)

(RAA riser or MR regulator required = SOLD SEPARATELY)

The Irripod pop up kit provides added protection to the Nelson R2000WF rotator in addition to being a safer product to use around young livestock. Because the kit includes a protective lid, young livestock cannot step into the pods, thus preventing sprinkler damage or hoof injury.

OFF

The picture to the right shows the pop up kit in the off (down) position, when the water is turned off:

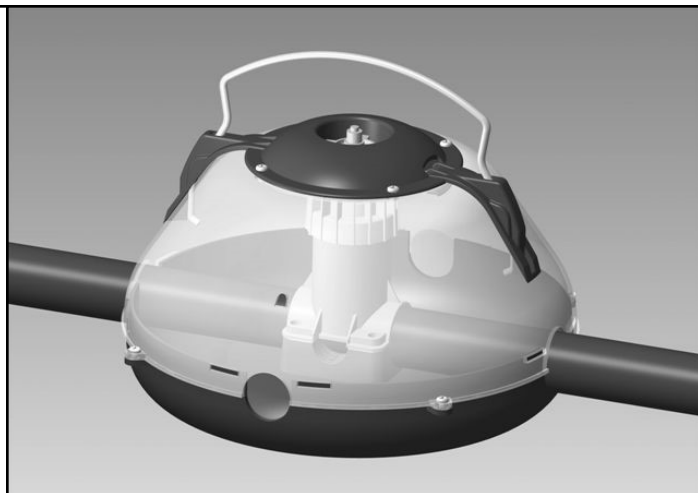





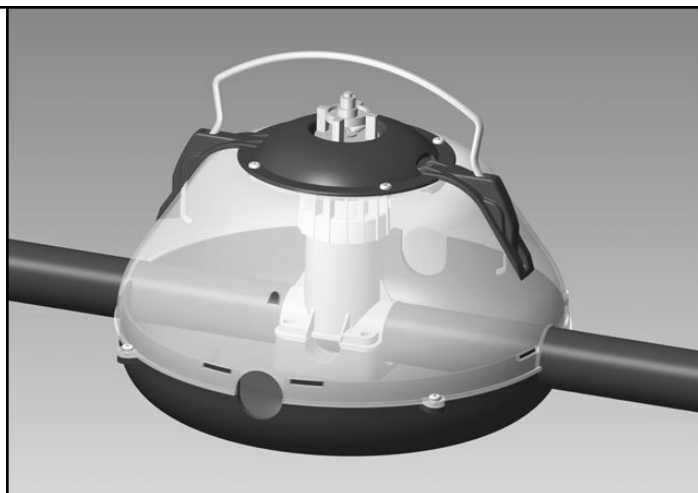

ON

The picture to the right shows the pop up kit in the on (up) position, when the water is turned on:



UNIVERSAL SALES ~ Irripod

Component C = Risers and Regulators

	PART #	LIST	DESCRIPTION
RISERS & ADAPTERS			
	IP RAA	5.90	R2000 FEMALE ACME X R2000 MALE ACME (RAISES SPRINKLER 2.5" FROM SADDLE)
	IP RAF 0.5	5.90	R2000 FEMALE ACME X 1/2" FPT (RAISES SPRINKLER 1.5" FROM SADDLE)
	IP RMF 0.5	0.60	1/2" MPT X 1/2" FPT (RAISES SPRINKLER 0.5" FROM 1/2" FPT)
	IP RAM 0.5	1.60	1/2" MPT X R2000 MALE ACME (ADAPTS NELSON R2000 TO 1/2" PIPE)
	IP RAM 0.75	1.60	3/4" MPT X R2000 MALE ACME (ADAPTS NELSON R2000 TO 3/4" PIPE)
	IP O-RING 0.5	0.64	O-RING FOR R2000 ACME

NELSON PRESSURE REGULATORS FOR ROTATORS (R2000 Acme thread X R2000 Acme thread)



IP MR30	10.00	30 PSI NELSON MINI REGULATOR
IP MR35	10.00	35 PSI NELSON MINI REGULATOR
IP MR40	10.00	40 PSI NELSON MINI REGULATOR
IP MR45	10.00	45 PSI NELSON MINI REGULATOR
IP MR50	10.00	50 PSI NELSON MINI REGULATOR



UNIVERSAL SALES ~ Irripod

Component D = Sprinklers and Rotators

NELSON LOW PRESSURE WIND FIGHTER ROTATORS (R2000 female Acme thread inlet)



acme

PART #	LIST	DESCRIPTION
IP R2000LP 1212	17.00	#12 PURPLE PLATE AND #12 PURPLE NOZZLE
IP R2000LP 1414	17.00	#14 GREEN PLATE AND #14 GREEN NOZZLE
IP R2000LP 1616	17.00	#16 RED PLATE AND #16 RED NOZZLE
IP R2000LP 1818	17.00	#18 GOLD PLATE AND #18 GOLD NOZZLE
IP R2000LP 2020	17.00	#20 BROWN PLATE AND #20 BROWN NOZZLE

DESIGNED TO OPERATE BETWEEN **25-50 PSI**.
OTHER NOZZLE AND PLATE OPTIONS AVAILABLE.
SEE PERFORMANCE CHARTS FOR MORE INFORMATION.

NELSON WIND FIGHTER ROTATORS (R2000 female Acme thread inlet)



acme

IP R2000WF 1212	17.00	#12 PURPLE PLATE AND #12 PURPLE NOZZLE
IP R2000WF 1414	17.00	#14 GREEN PLATE AND #14 GREEN NOZZLE
IP R2000WF 1616	17.00	#16 RED PLATE AND #16 RED NOZZLE
IP R2000WF 1818	17.00	#18 GOLD PLATE AND #18 GOLD NOZZLE

DESIGNED TO OPERATE BETWEEN **40-65 PSI**.
OTHER NOZZLE AND PLATE OPTIONS AVAILABLE.
SEE PERFORMANCE CHARTS FOR MORE INFORMATION.

NELSON WIND FIGHTER ROTATOR ACCESSORIES



IP R2000 LW 0.50 LOCK WASHER FOR WIND FIGHTER ACME THREAD



IP AC 1.50 R2000 ACME CAP



IP R2000 RGHA 6.00 ROAD GUARD (High Angle) FOR WIND FIGHTER

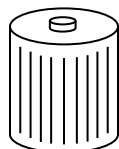

IP R2000 FT 13.00 FLUSH TOOL FOR WIND FIGHTER



UNIVERSAL SALES ~ Irripod

Component D = Sprinklers and Rotators

NELSON R33 3/4" ROTATORS (3/4" male pipe thread inlet)



PART #	LIST	DESCRIPTION
IP R33 9/64	29.00	3/4" rotator, gold plate, gold nozzle
IP R33 5/32	29.00	3/4" rotator, brown plate, brown nozzle
IP R33 11/64	29.00	3/4" rotator, gold plate, grey nozzle
IP R33 3/16	29.00	3/4" rotator, gold plate, green nozzle
IP R33 RG	14.00	Road Guard for R33 rotator

DESIGNED TO OPERATE BETWEEN **40-65 PSI**.
 OTHER NOZZLE AND PLATE OPTIONS AVAILABLE.
 SEE PERFORMANCE CHARTS FOR MORE INFORMATION.



SENNINGER 1/2" PLASTIC IMPACTS (1/2" MPT inlet)



IP S2023 7/64	19.00	1/2" MPT, 23degree, with 7/64" nozzle
IP S2023 1/8	19.00	1/2" MPT, 23degree, with 1/8" nozzle
IP S2023 9/64	19.00	1/2" MPT, 23degree, with 9/64" nozzle

DESIGNED TO OPERATE BETWEEN **25-50 PSI**.
 OTHER NOZZLES AVAILABLE.
 SEE PERFORMANCE CHARTS FOR MORE INFORMATION.

SENNINGER 3/4" PLASTIC IMPACTS (3/4" MPT inlet)



IP S3023 1/8	24.50	3/4" MPT, 23degree, with 1/8" nozzle
IP S3023 9/64	24.50	3/4" MPT, 23degree, with 9/64" nozzle
IP S3023 5/32	24.50	3/4" MPT, 23degree, with 5/32" nozzle

DESIGNED TO OPERATE BETWEEN **25-60 PSI**.
 OTHER NOZZLES AVAILABLE.
 SEE PERFORMANCE CHARTS FOR MORE INFORMATION.

SENNINGER IMPACT NOZZLES (Hand Tight Nozzle with Vane for 20 and 30 series)



IP SN 7/64	2.30	Senninger #7 Lime Nozzle
IP SN 1/8	2.30	Senninger #8 Lavender Nozzle
IP SN 9/64	2.30	Senninger #9 Grey Nozzle
IP SN 5/32	2.30	Senninger #10 Turquoise Nozzle





UNIVERSAL SALES ~ Irripod





Component E = Tube and Fittings

	PART #	LIST	DESCRIPTION
IRRIPOD TUBE			
POLYETHYLENE BLEND FOR IRRIPOD			
	IP 1.5 300	420.00	1.5" I.D. POLY TUBE X 300' COIL (90 LBS)
	IP 1.5 450	630.00	1.5" I.D. POLY TUBE X 450' COIL (135 LBS)
	IP 1.75 300	540.00	1.75" I.D. POLY TUBE X 300' COIL (105 LBS)

TUBE RATCHET CUTTER

	IP RC 2.5	60.00	RATCHET CUTTER (UP TO 2.5" OD)	
	IP RC 2.5 B	23.00	REPLACEMENT BLADE FOR IP-RC-2.5	

TOW HOOKS

	IP 1.5 THR	38.60	1.5" IRRIPOD BARB X TOW HOOK + ROPE (INCLUDES 6' OF ROPE)
	IP 1.5M THR	43.00	STEEL (plated) 1.5" MPT X TOW HOOK + ROPE (INCLUDES 6' OF ROPE) = IDEAL FOR USE WITH CAM LOCK SETUPS
	IP 1.75 THR	41.80	1.75" IRRIPOD BARB X TOW HOOK + ROPE (INCLUDES 6' OF ROPE)
	IP 2.0 THR	34.30	2.0" MPT X TOW HOOK + ROPE (INCLUDES 6' OF ROPE) = IDEAL FOR USE WITH CAM LOCK SETUPS

COUPLERS & REDUCING COUPLERS

	IP 1.5 C	11.80	1.5" IRRIPOD BARB X 1.5" IRRIPOD BARB
	IP 1.75 C	17.20	1.75" IRRIPOD BARB X 1.75" IRRIPOD BARB
	IP 1.75 RC 1.5	22.50	1.75" IRRIPOD BARB X 1.5" IRRIPOD BARB



UNIVERSAL SALES ~ Irripod

Component E = Tube and Fittings (continued)

	PART #	LIST	DESCRIPTION
--	--------	------	-------------

THREADED ADAPTERS



IP 1.5 FA

10.70

1.5" IRRIPOD BARB X 1.5" FPT



IP 1.75 MA

11.80

1.75" IRRIPOD BARB X 2" MPT



IP 1.5 U

29.00

1.5" MPT X 1.5" MPT UNION

CAM LOCK FITTINGS

"E"



IP CLE 1.5

15.00

1.5" CAM LOCK MALE X 1.5" IRRIPOD BARB

IP CLE 1.75

19.80

2.0" CAM LOCK MALE X 1.75" IRRIPOD BARB

"D"



IP CLD 1.5

11.00

1.5" CAM LOCK FEMALE X 1.5" FPT

IP CLD 2.0

13.00

2.0" CAM LOCK FEMALE X 2.0" FPT

"B"



IP CLB 1.5

11.00

1.5" CAM LOCK FEMALE X 1.5" MPT

IP CLB 2.0

14.50

2.0" CAM LOCK FEMALE X 2.0" MPT

"A"



IP CLA 1.5

3.00

1.5" CAM LOCK MALE X 1.5" FPT

IP CLA 2.0

4.00

2.0" CAM LOCK MALE X 2.0" FPT

"F"



IP CLF 1.5

3.00

1.5" CAM LOCK MALE X 1.5" MPT

IP CLF 2.0

4.50

2.0" CAM LOCK MALE X 2.0" MPT

"DC"



IP CLDC 1.5

12.00

1.5" CAM LOCK DUST CAP

IP CLDC 2.0

13.00

2.0" CAM LOCK DUST CAP

"DP"



IP CLDP 1.5

3.00

1.5" CAM LOCK DUST PLUG

IP CLDP 2.0





4.00





2.0" CAM LOCK DUST PLUG



UNIVERSAL SALES ~ Irripod

Component E = Tube and Fittings (continued)



	PART #	LIST	DESCRIPTION
<u>SHORT HOOK ADAPTER FITTINGS FOR VALVE OPENING ELBOWS (GALVANIZED)</u>			
	IP 1.5M 2SH	36.00	1.5" MPT X 2" OD WITH SHORT HOOK SWIVEL
	IP 1.5M 3SH	57.00	1.5" MPT X 3" OD WITH SHORT HOOK SWIVEL
	IP 2.0F 3SH	60.00	2.0" FPT X 3" OD WITH SHORT HOOK SWIVEL
	IP 2.0F 4SH	78.00	2.0" FPT X 4" OD WITH SHORT HOOK SWIVEL
	IP SH	5.00	SHORT HOOK ONLY

<u>LONG HOOK ADAPTER FITTINGS FOR VALVE OPENING ELBOWS (GALVANIZED)</u>			
	IP 1.5M 2LH	39.00	1.5" MPT X 2" OD WITH LONG HOOK SWIVEL
	IP 1.5M 3LH	60.00	1.5" MPT X 3" OD WITH LONG HOOK SWIVEL
	IP 2.0F 3LH	63.00	2.0" FPT X 3" OD WITH LONG HOOK SWIVEL
	IP 2.0F 4LH	81.00	2.0" FPT X 4" OD WITH LONG HOOK SWIVEL
	IP LH	8.00	LONG HOOK ONLY



UNIVERSAL SALES ~ Irripod

Component E = Tube and Fittings (continued)

	PART #	LIST	DESCRIPTION
QUICK COUPLING VALVES - BRASS			
	IP 1.5 QCS	73.00	1.5" QUICK COUPLING SWIVEL ELL (1.5" FPT SWIVEL X 1.5" MPT)
	IP 1.5 QCK	94.00	1.5" QUICK COUPLING KEY (1.5" MPT OUTLET ON TOP)
	IP 1.5 QCV	104.00	1.5" QUICK COUPLING VALVE (1.5" FPT INLET)

BALL VALVES



IP BV 1.5 53.00 1.5" FPT IRRIPOD BALL VALVE

IP BV 2.0 68.00 2.0" FPT IRRIPOD BALL VALVE



High quality glass reinforced nylon body.
Removable blue plastic handle.



UNIVERSAL SALES ~ Irripod

PART # LIST DESCRIPTION

IRRIPOD PARTS



IP DOME W 32.50 WHITE DOME

IP DOME B 37.50 BLACK DOME



IP BASE 35.00 BLACK BASE



IP WIRE 12.80 WIRE GUARD



IP WIRE CLIP 4.30 PLASTIC CLIP FOR WIRE GUARD
(sold individually, 2 required per wire guard)



IP TST O-RING 0.54 O-RING FOR IRRIPOD SADDLES



IP 1.75 CTA 8.60 CROSS TEE ANCHOR FOR 1.75" & 1.5"
IRRIPOD TUBING

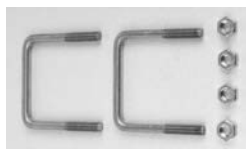

IP UBOLTS 24.50 SET OF U-BOLTS AND NUTS
FOR CROSS TEE ANCHOR



IP SCREWS 6.74 SET OF SCREWS FOR
POD DOME & WIRE CLIPS



UNIVERSAL SALES ~ Irripod

PART #	LIST	DESCRIPTION
1" SINGLE POD HANDLE		
IP 1.0 HANDLE	27.00	1.0" MPT INLET X 3/4" FPT OUTLET WITH HANDLE



Pod not included.
Shown for
illustration only.



2" CROSS TEE MANIFOLD



IP 2.0 CTM	20.00	2.0" CROSS TEE MANIFOLD
------------	-------	-------------------------

4 = 2" FPT ports in cross pattern.

Can be mounted on pod skid base (sold separately).

Ideally suited for above ground sub-main that can be moved around the field.

Attach 1.75" Irripod tubing, cam lock fittings, ball valves, or a combination to suit your application.

Base not included.
Shown for
illustration only.



IP-HMTD Hitch Mount Tube Dispenser



<u>PART #</u>	<u>LIST</u>	<u>DESCRIPTION</u>
IP HMTD	750.00	Hitch Mount Tube Dispenser

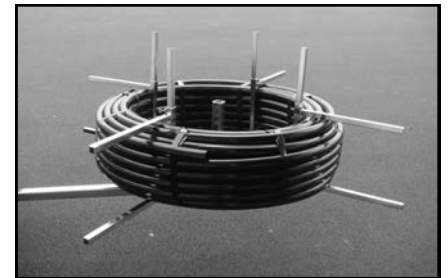

The Hitch Mount Tube Dispenser (HMTD) has been designed to help install Irripod tubing faster and easier. It is fully adjustable, easy to take apart for transport and storage, and plated for long service life.



UNIVERSAL SALES ~ Irripod

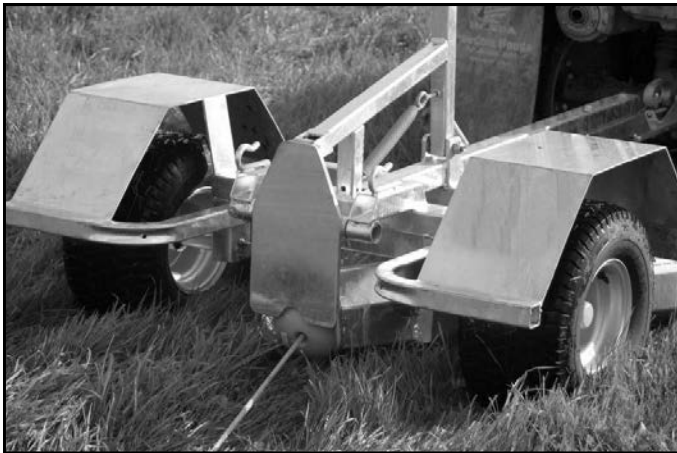

	PART #	LIST	DESCRIPTION
TOW TRAILER & BALL			

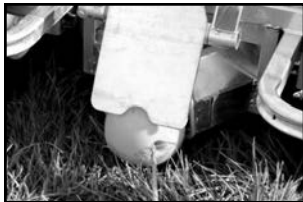

IP TT	call for quote	TOW TRAILER
IP TB	26.80	TOW BALL

With the Irripod tow trailer, Irripod lines can be shifted without getting off/out of the vehicle:

- 1) Connect tow balls to each tow rope on the end of each Irripod line.
- 2) Drive the trailer over the tow ball and the trailer will automatically catch the ball.
- 3) Shift the Irripod line to the next location.
- 4) Release the tow ball from the trailer by pulling on the release mechanism.

FENCE SIGNS

1	IP FS SET	150.00	14 NUMBERED FENCE SIGNS #1 to #14
14	Use fence signs to mark each Irripod shift position.		



UNIVERSAL SALES ~ Irripod

Friction Loss Charts:

1.5"

Standard Friction Loss Characteristics		
1.5" Inside Diameter Polyethylene Pipe		
version: 3-1-08		
Flow	Head loss	Velocity
GPM	psi/100'	ft/sec
1	0.01	0.18
2	0.02	0.36
3	0.05	0.54
4	0.08	0.72
5	0.12	0.91
6	0.16	1.09
7	0.22	1.27
8	0.28	1.45
9	0.35	1.63
10	0.42	1.81
11	0.50	1.99
12	0.59	2.17
14	0.79	2.54
16	1.01	2.90
18	1.25	3.26
20	1.52	3.62
22	1.81	3.99
24	2.13	4.35
26	2.47	4.71
28	2.83	5.07
30	3.22	5.44
35	4.28	6.34
40	5.49	7.25
Friction loss calculated using Hazen-Williams formula and a smoothness constant of 150.		
This information is estimated using formulas - actual field conditions may vary.		
Low Density Polyethylene	Temperature	Pressure
	Degrees Fahrenheit	Rating PSI
1.5" ID x 1.75" OD	70	90
	80	84
	90	77
	100	70
	110	62
	120	54
Pressure ratings are estimated typical values only and are not guaranteed.		

1.75"

Standard Friction Loss Characteristics		
1.75" Inside Diameter Polyethylene Pipe		
version: 3-1-08		
Flow	Head loss	Velocity
GPM	psi/100'	ft/sec
1	0.00	0.13
2	0.01	0.27
3	0.02	0.40
4	0.04	0.53
5	0.06	0.67
6	0.08	0.80
7	0.10	0.93
8	0.13	1.07
9	0.16	1.20
10	0.20	1.33
11	0.24	1.46
12	0.28	1.60
14	0.37	1.86
16	0.47	2.13
18	0.59	2.40
20	0.72	2.66
22	0.86	2.93
24	1.01	3.20
26	1.17	3.46
28	1.34	3.73
30	1.52	3.99
35	2.02	4.66
40	2.59	5.33
45	3.22	5.99
50	3.92	6.66
55	4.67	7.32
Friction loss calculated using Hazen-Williams formula and a smoothness constant of 150.		
This information is estimated using formulas - actual field conditions may vary.		
Low Density Polyethylene	Temperature	Pressure
	Degrees Fahrenheit	Rating PSI
1.75" ID x 2.0" OD	70	80
	80	76
	90	70
	100	62
	110	56
	120	50
Pressure ratings are estimated typical values only and are not guaranteed.		



UNIVERSAL SALES ~ Irripod

Rotator and Sprinkler Performance:



Nelson Irrigation								
R2000LP Low Pressure Wind Fighter Rotator								
Performance Chart								
Plate	Nozzle	Radius	GPM at Stated PSI					
			25	30	35	40	45	50
12 purple	10 blue	34' to 37'	0.88	0.97	1.05	1.12	1.19	1.25
	11 orange		1.07	1.17	1.27	1.36	1.45	1.53
	12 purple		1.27	1.39	1.50	1.61	1.70	1.80
14 green	13 yellow	39' to 41'	1.50	1.64	1.78	1.90	2.02	2.13
	14 green		1.70	1.85	2.00	2.15	2.28	2.40
16 red	15 tan	40' to 42'	1.98	2.17	2.35	2.53	2.67	2.82
	16 red		2.28	2.50	2.70	2.89	3.07	3.23
18 gold	18 gold	41' to 43'	2.92	3.20	3.44	3.68	3.89	4.11
20 brown	20 brown	42' to 45'	3.56	3.90	4.18	4.48	4.76	5.00



Senninger Irrigation						
3023 Series 3/4" Impact						
Performance Chart						
Nozzle		PSI				
		30	35	40	45	50
7/64"	GPM	1.84	1.99	2.12	2.25	2.37
	Diam Ft	80	82	84	86	87
1/8"	GPM	2.42	2.62	2.79	2.97	3.12
	Diam Ft	83	85	86	87	88
9/64"	GPM	3.08	3.33	3.56	3.78	3.98
	Diam Ft	85	87	88	90	91
5/32"	GPM	3.82	4.13	4.41	4.68	4.93
	Diam Ft	87	89	90	91	92

For other sprinklers and more information visit our website: www.universalsales.biz

Design information for reference only. Actual performance may vary depending on real life conditions in the field. While every effort has been made to ensure accuracy in regards to information contained in this publication, neither Universal Sales, Irripod, Nelson, Senninger, nor any employees of these companies, shall be liable on any grounds whatsoever to any party in respect of decisions or actions they may make as a result of using this information. These companies reserve the right to make changes without notice to any service or product specification.





UNIVERSAL SALES

Irripod Flexible Irrigation

www.universalsales.biz ~ PH (541) 998-9999 ~ FX (541) 998-9998

TERMS AND CONDITIONS

TERMS:

Net 10th of month following the invoice date. A 1 1/2% per month service charge will be added to all past due accounts.

MINIMUM ORDER:

There is no minimum invoice amount, however a \$5.00 service charge will be added to invoices under \$50.00. This does not apply to backorders.

CREDIT:

Credit approval for an open account and discount eligibility must be established prior to initial order. COD may be requested for accounts with credit applications in process. Shipments will be held on established accounts with an unsatisfactory payment status.

PRICES:

We reserve the right to change prices without notice. However, we will endeavor to announce price changes 30 days prior to the date of effectiveness. Unless noted otherwise on our sales acknowledgment, prices are those in effect at time of shipment.

SHORTAGES:

All claims such as pricing, shortages, returns, etc. must be made within 10 days from receipt of shipment in writing. All shortages should be identified by giving us the invoice number and date on which merchandise was invoiced. No debit memo will be accepted until final disposition is determined and factory credit memo is issued.

PRODUCT DESIGN:

Manufacturer reserves the right to redesign, alter, or modify its products without incurring liability for customer's inventory or future compatibility.

DEFECTIVE MATERIALS:

Contact sales office for field inspection prior to any disposition of material. No debit memos, freight charges, returns, etc. will be honored without corporate authorization.

MERCHANDISE RETURNED FOR CREDIT:

No merchandise will be accepted without prior approval of the nearest Universal Sales warehouse. All materials approved for return shall be returned freight prepaid and are subject to a 20% restocking charge.



DAMAGED FREIGHT:

Products are packaged and accepted by the freight forwarder in undamaged condition. Do not sign for damaged freight without noting damages on the waybill. Notify Universal Sales headquarters immediately for instructions on how to proceed.