



UNIVERSAL SALES

irripod

FLEXIBLE IRRIGATION

Catalog ~ Price list

Effective: 3-1-2020



UNIVERSAL SALES
92311 Booth Street
Junction City, OR 97448
www.universalsales.biz

Phone : 541-998-9999
Fax : 541-998-9998
Toll Free Fax : 888-998-7998
Email : Universal@UniversalSales.biz



Irripod Component System

Pods are sold "a la carte" so that the appropriate saddles and fittings can be purchased for each project, lowering the initial installation cost:

Component A = Pods

Component B = Tapping Saddle Tops

Component C = Risers & Regulators

Component D = Sprinklers & Rotators

Component E = Tube & Fittings

"Ranch pack" kits are also available that include all the parts needed.

Irripod Catalog Table of Contents

Ranch Packs	Page 3
Component A = Pods	Page 4
Component B = Tapping Saddle Tops	Page 5-6
Component C = Risers and Regulators	Page 7
Component D = Sprinklers and Rotators	Page 8-9
Component E = Tube and Fittings	Page 10-13
Parts	Page 14-15
Hitch Mount Tube Dispenser	Page 16
Tow Trailer	Page 17
Friction Loss Charts	Page 18
Sprinkler and Rotator Performance Charts	Page 19
Terms and Conditions	Page 20



UNIVERSAL SALES ~ Irripod

Ranch Pack - 5 Pod 2 Acre Kit

The 5 pod Ranch Pack is ideal for about 2 acres of pasture.
(200'x400' maximum)

Included are 300' of 1.5" Irripod tube, 5 pods, 5 saddles, 5 sprinklers with 3 sets of nozzles, and all the fittings required. All that is needed is a 1.5" MPT water supply connection at the center of the area to be irrigated.

Ranch Pack - 8 Pod 3 Acre Kit

The 8 pod Ranch Pack is ideal for about 3 acres of pasture.
(200'x725' maximum)

Included are 450' of 1.5" Irripod tube, 8 pods, 8 saddles, 8 sprinklers with 3 sets of nozzles, and all the fittings required. All that is needed is a 1.5" MPT water supply connection at the center of the area to be irrigated.

PART #	LIST	DESCRIPTION
--------	------	-------------

IP RP5	1,323.40	5 POD RANCH PACK
IP RP8	2,005.30	8 POD RANCH PACK



See the Ranch Pack brochures for more information and pictures:
www.universalsales.biz

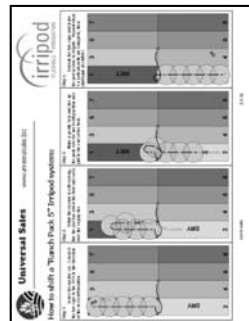

UNIVERSAL SALES ~ Irripod

Component A = Pods

IRRIPOD PODS

PART # LIST DESCRIPTION



IP 1.75 POD 119.00 POD FOR 1.5" & 1.75" IRRIPOD TUBE
(7 PER BOX)

EACH POD COMES WITH:



1 = IP DOME W (white dome) call for other colors



1 = IP BASE (black base)



1 = IP WIRE (wire guard)



2 = IP WIRE CLIP (plastic clip for wire guard)



1 = IP TST O-RING (O-Ring for Irripod saddles)



1 = IP 1.75 CTA (cross tee anchor for 1.5" & 1.75" Irripod tube)

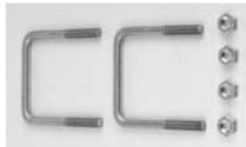

1 = IP UBOLTS (set of u bolts and nuts for cross tee anchor)



1 = IP SCREWS (set of screws for pod dome & wire clips)

IP TSK40-45LDU
\$66.00 LIST
(Pod kit without
dome & base)

For individual
part prices,
see page 14.





UNIVERSAL SALES ~ Irripod

Component B = Tapping Saddle Tops

	PART #	LIST	DESCRIPTION
--	--------	------	-------------

1.5"	acme 	IP TST 1.5-A 8.50	1.5" saddle x R2000 Acme thread
------	---	----------------------	---------------------------------

1.5"	1/2" 	IP TST 1.5-1/2 8.50	1.5" saddle x 1/2" FPT high riser
------	---	------------------------	-----------------------------------

1.5"	3/4" 	IP TST 1.5-3/4 14.50	1.5" saddle x 3/4" MPT comes with 1 = 3/4" FPT Coupler
------	---	-------------------------	---

				1.5"

1.75"	1/2" 	IP TST 1.75-1/2 8.50	1.75" saddle x 1/2" FPT high riser	1.75"

1.75"	3/4" 	IP TST 1.75-3/4 14.50	1.75" saddle x 3/4" MPT comes with 1 = 3/4" FPT Coupler
-------	---	--------------------------	--



UNIVERSAL SALES ~ Irripod

Component B = Tapping Saddle Tops (continued)

	PART #	LIST	DESCRIPTION
IRRIPOD 1.5" POP UP KIT			



IP TST 1.5-POP

45.00

POP UP KIT FOR 1.5" IRRIPOD

(USE WITH NELSON R2000WF = SOLD SEPARATELY)

(RAA riser or MR regulator required = SOLD SEPARATELY)

The Irripod pop up kit provides added protection to the Nelson R2000WF rotator in addition to being a safer product to use around young livestock. Because the kit includes a protective lid, young livestock cannot step into the pods, thus preventing sprinkler damage or hoof injury.

OFF

The picture to the right shows the pop up kit in the off (down) position, when the water is turned off:

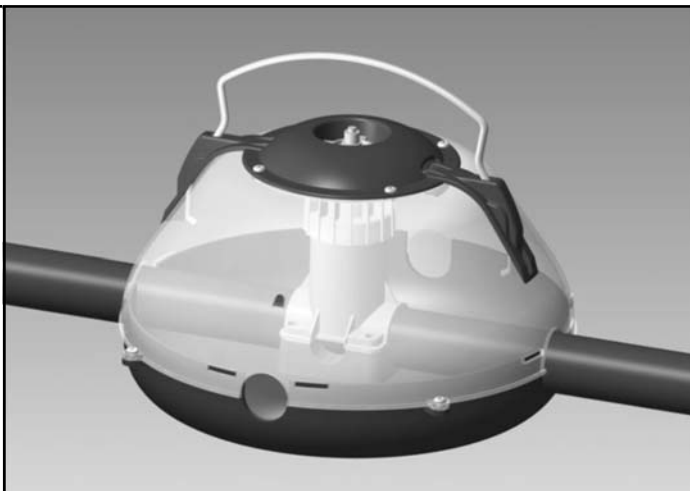





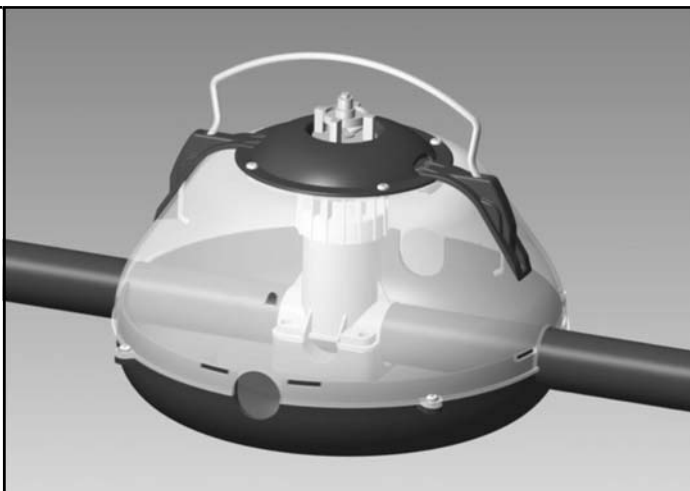

ON

The picture to the right shows the pop up kit in the on (up) position, when the water is turned on:



UNIVERSAL SALES ~ Irripod

Component C = Risers and Regulators

	PART #	LIST	DESCRIPTION
RISERS & ADAPTERS			
	IP RAA	6.30	R2000 FEMALE ACME X R2000 MALE ACME (RAISES SPRINKLER 2.5" FROM SADDLE)
	IP RAF 0.5	6.30	R2000 FEMALE ACME X 1/2" FPT (RAISES SPRINKLER 1.5" FROM SADDLE)
	IP RMF 0.5	0.64	1/2" MPT X 1/2" FPT (RAISES SPRINKLER 0.5" FROM 1/2" FPT)
	IP RAM 0.5	1.80	1/2" MPT X R2000 MALE ACME (ADAPTS NELSON R2000 TO 1/2" PIPE)
	IP RAM 0.75	1.80	3/4" MPT X R2000 MALE ACME (ADAPTS NELSON R2000 TO 3/4" PIPE)
	IP O-RING 0.5	0.70	O-RING FOR R2000 ACME

NELSON PRESSURE REGULATORS FOR ROTATORS (R2000 Acme thread X R2000 Acme thread)



IP MR30	11.00	30 PSI NELSON MINI REGULATOR
IP MR35	11.00	35 PSI NELSON MINI REGULATOR
IP MR40	11.00	40 PSI NELSON MINI REGULATOR
IP MR45	11.00	45 PSI NELSON MINI REGULATOR
IP MR50	11.00	50 PSI NELSON MINI REGULATOR



UNIVERSAL SALES ~ Irripod

Component D = Sprinklers and Rotators

PART # LIST DESCRIPTION

NELSON LOW PRESSURE WIND FIGHTER ROTATORS (R2000 female Acme thread inlet)



acme

IP R2000LP 1212	19.00	#12 PURPLE PLATE AND #12 PURPLE NOZZLE
IP R2000LP 1414	19.00	#14 GREEN PLATE AND #14 GREEN NOZZLE
IP R2000LP 1616	19.00	#16 RED PLATE AND #16 RED NOZZLE
IP R2000LP 1818	19.00	#18 GOLD PLATE AND #18 GOLD NOZZLE
IP R2000LP 2020	19.00	#20 BROWN PLATE AND #20 BROWN NOZZLE

DESIGNED TO OPERATE BETWEEN **25-50 PSI**.
OTHER NOZZLE AND PLATE OPTIONS AVAILABLE.
SEE PERFORMANCE CHARTS FOR MORE INFORMATION.

NELSON WIND FIGHTER ROTATORS (R2000 female Acme thread inlet)



acme

IP R2000WF 1212	19.00	#12 PURPLE PLATE AND #12 PURPLE NOZZLE
IP R2000WF 1414	19.00	#14 GREEN PLATE AND #14 GREEN NOZZLE
IP R2000WF 1616	19.00	#16 RED PLATE AND #16 RED NOZZLE
IP R2000WF 1818	19.00	#18 GOLD PLATE AND #18 GOLD NOZZLE

DESIGNED TO OPERATE BETWEEN **40-65 PSI**.
OTHER NOZZLE AND PLATE OPTIONS AVAILABLE.
SEE PERFORMANCE CHARTS FOR MORE INFORMATION.

NELSON WIND FIGHTER ROTATOR ACCESSORIES



IP R2000 LW 0.55 LOCK WASHER FOR WIND FIGHTER ACME THREAD



IP AC 1.70 R2000 ACME CAP



IP R2000 RGHA 6.60 ROAD GUARD (High Angle) FOR WIND FIGHTER

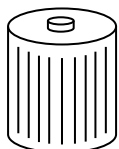

IP R2000 FT 14.60 FLUSH TOOL FOR WIND FIGHTER



UNIVERSAL SALES ~ Irripod

Component D = Sprinklers and Rotators

NELSON R33 3/4" ROTATORS (3/4" male pipe thread inlet)



3/4"

PART #	LIST	DESCRIPTION
IP R33 9/64	33.00	3/4" rotator, gold plate, gold nozzle
IP R33 5/32	33.00	3/4" rotator, brown plate, brown nozzle
IP R33 11/64	33.00	3/4" rotator, gold plate, grey nozzle
IP R33 3/16	33.00	3/4" rotator, gold plate, green nozzle
IP R33 RG	15.70	Road Guard for R33 rotator



DESIGNED TO OPERATE BETWEEN **40-65 PSI**.
 OTHER NOZZLE AND PLATE OPTIONS AVAILABLE.
 SEE PERFORMANCE CHARTS FOR MORE INFORMATION.

SENNINGER 1/2" PLASTIC IMPACTS (1/2" MPT inlet)



1/2"

IP S2023 7/64	19.00	1/2" MPT, 23degree, with 7/64" nozzle
IP S2023 1/8	19.00	1/2" MPT, 23degree, with 1/8" nozzle
IP S2023 9/64	19.00	1/2" MPT, 23degree, with 9/64" nozzle

DESIGNED TO OPERATE BETWEEN **25-50 PSI**.
 OTHER NOZZLES AVAILABLE.
 SEE PERFORMANCE CHARTS FOR MORE INFORMATION.

SENNINGER 3/4" PLASTIC IMPACTS (3/4" MPT inlet)



3/4"

IP S3023 1/8	25.00	3/4" MPT, 23degree, with 1/8" nozzle
IP S3023 9/64	25.00	3/4" MPT, 23degree, with 9/64" nozzle
IP S3023 5/32	25.00	3/4" MPT, 23degree, with 5/32" nozzle

DESIGNED TO OPERATE BETWEEN **25-60 PSI**.
 OTHER NOZZLES AVAILABLE.
 SEE PERFORMANCE CHARTS FOR MORE INFORMATION.

SENNINGER IMPACT NOZZLES (Hand Tight Nozzle with Vane for 20 and 30 series)



IP SN 7/64	2.90	Senninger #7 Lime Nozzle
IP SN 1/8	2.90	Senninger #8 Lavender Nozzle
IP SN 9/64	2.90	Senninger #9 Grey Nozzle
IP SN 5/32	2.90	Senninger #10 Turquoise Nozzle



UNIVERSAL SALES ~ Irripod

Component E = Tube and Fittings

	PART #	LIST	DESCRIPTION
IRRIPOD TUBE			
POLYETHYLENE BLEND FOR IRRIPOD			
	IP 1.5 300	450.00	1.5" I.D. POLY TUBE X 300' COIL (90 LBS)
	IP 1.5 450	675.00	1.5" I.D. POLY TUBE X 450' COIL (135 LBS)
	IP 1.75 300	580.00	1.75" I.D. POLY TUBE X 300' COIL (105 LBS)

TUBE RATCHET CUTTER



IP RC 2.5	call	RATCHET CUTTER (UP TO 2.5" OD)
IP RC 2.5 B	call	REPLACEMENT BLADE FOR IP-RC-2.5



TOW HOOKS



IP 1.5 THR	41.00	1.5" IRRIPOD BARB X TOW HOOK + ROPE (INCLUDES 6' OF ROPE)
------------	-------	--



IP 1.5M THR	52.00	STEEL (plated) 1.5" MPT X TOW HOOK + ROPE (INCLUDES 6' OF ROPE) = IDEAL FOR USE WITH CAM LOCK SETUPS
-------------	-------	--



IP 1.75 THR	44.50	1.75" IRRIPOD BARB X TOW HOOK + ROPE (INCLUDES 6' OF ROPE)
-------------	-------	---



IP 2.0 THR	36.50	2.0" MPT X TOW HOOK + ROPE (INCLUDES 6' OF ROPE) = IDEAL FOR USE WITH CAM LOCK SETUPS
------------	-------	---

COUPLERS & REDUCING COUPLERS



IP 1.5 C	12.60	1.5" IRRIPOD BARB X 1.5" IRRIPOD BARB
IP 1.75 C	18.40	1.75" IRRIPOD BARB X 1.75" IRRIPOD BARB
IP 1.75 RC 1.5	24.00	1.75" IRRIPOD BARB X 1.5" IRRIPOD BARB





UNIVERSAL SALES ~ Irripod

Component E = Tube and Fittings (continued)

	PART #	LIST	DESCRIPTION
--	--------	------	-------------

THREADED ADAPTERS

	IP 1.5 FA	11.50	1.5" IRRIPOD BARB X 1.5" FPT
	IP 1.75 MA	12.80	1.75" IRRIPOD BARB X 2" MPT
	IP 1.5 U	31.00	1.5" MPT X 1.5" MPT UNION

CAM LOCK FITTINGS





"E"		IP CLE 1.5	16.00	1.5" CAM LOCK MALE X 1.5" IRRIPOD BARB
		IP CLE 1.75	21.00	2.0" CAM LOCK MALE X 1.75" IRRIPOD BARB
"D"		IP CLD 1.5	13.70	1.5" CAM LOCK FEMALE X 1.5" FPT
		IP CLD 2.0	16.10	2.0" CAM LOCK FEMALE X 2.0" FPT
"B"		IP CLB 1.5	13.70	1.5" CAM LOCK FEMALE X 1.5" MPT
		IP CLB 2.0	18.00	2.0" CAM LOCK FEMALE X 2.0" MPT
"A"		IP CLA 1.5	3.70	1.5" CAM LOCK MALE X 1.5" FPT
		IP CLA 2.0	5.00	2.0" CAM LOCK MALE X 2.0" FPT
"F"		IP CLF 1.5	3.70	1.5" CAM LOCK MALE X 1.5" MPT
		IP CLF 2.0	5.60	2.0" CAM LOCK MALE X 2.0" MPT
"DC"		IP CLDC 1.5	14.90	1.5" CAM LOCK DUST CAP
		IP CLDC 2.0	16.10	2.0" CAM LOCK DUST CAP
"DP"		IP CLDP 1.5	3.70	1.5" CAM LOCK DUST PLUG
		IP CLDP 2.0	5.00	2.0" CAM LOCK DUST PLUG







UNIVERSAL SALES ~ Irripod

Component E = Tube and Fittings (continued)

SHORT HOOK ADAPTER FITTINGS FOR VALVE OPENING ELBOWS (GALVANIZED)

	PART #	LIST	DESCRIPTION
	IP 1.5M 2SH	47.00	1.5" MPT X 2" OD WITH SHORT HOOK SWIVEL
	IP 1.5M 3SH	69.00	1.5" MPT X 3" OD WITH SHORT HOOK SWIVEL
	IP 2.0F 3SH	69.00	2.0" FPT X 3" OD WITH SHORT HOOK SWIVEL
	IP 2.0F 4SH	94.00	2.0" FPT X 4" OD WITH SHORT HOOK SWIVEL
	IP SH	5.90	SHORT HOOK ONLY



LONG HOOK ADAPTER FITTINGS FOR VALVE OPENING ELBOWS (GALVANIZED)

	IP 1.5M 2LH	50.00	1.5" MPT X 2" OD WITH LONG HOOK SWIVEL
	IP 1.5M 3LH	72.00	1.5" MPT X 3" OD WITH LONG HOOK SWIVEL
	IP 2.0F 3LH	72.00	2.0" FPT X 3" OD WITH LONG HOOK SWIVEL
	IP 2.0F 4LH	97.00	2.0" FPT X 4" OD WITH LONG HOOK SWIVEL
	IP LH	8.90	LONG HOOK ONLY



UNIVERSAL SALES ~ Irripod

Component E = Tube and Fittings (continued)

	PART #	LIST	DESCRIPTION
	IP 1.5 QCS	88.00	1.5" QUICK COUPLING SWIVEL ELL (1.5" FPT SWIVEL X 1.5" MPT)
	IP 1.5 QCK	109.00	1.5" QUICK COUPLING KEY (1.5" MPT OUTLET ON TOP)
	IP 1.5 QCV	119.00	1.5" QUICK COUPLING VALVE (1.5" FPT INLET)

BALL VALVES



IP BV 1.5 56.00 1.5" FPT IRRIPOD BALL VALVE

IP BV 2.0 73.00 2.0" FPT IRRIPOD BALL VALVE



High quality glass reinforced nylon body.
Removable blue plastic handle.



UNIVERSAL SALES ~ Irripod

PART # LIST DESCRIPTION

IRRIPOD PARTS



IP DOME W 35.00 WHITE DOME

IP DOME B 40.00 BLACK DOME



IP BASE 37.00 BLACK BASE



IP WIRE 13.70 WIRE GUARD



IP WIRE CLIP 4.50 PLASTIC CLIP FOR WIRE GUARD
(sold individually, 2 required per wire guard)



IP TST O-RING 0.58 O-RING FOR IRRIPOD SADDLES



IP 1.75 CTA 9.20 CROSS TEE ANCHOR FOR 1.75" & 1.5"
IRRIPOD TUBING

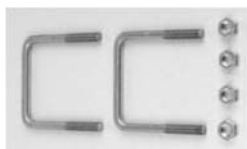

IP UBOLTS 27.00 SET OF U-BOLTS AND NUTS
FOR CROSS TEE ANCHOR



IP SCREWS 7.20 SET OF SCREWS FOR
POD DOME & WIRE CLIPS



UNIVERSAL SALES ~ Irripod

PART #	LIST	DESCRIPTION
1" SINGLE POD HANDLE		
IP 1.0 HANDLE	29.00	1.0" MPT INLET X 3/4" FPT OUTLET WITH HANDLE



Pod not included.
Shown for
illustration only.



2" CROSS TEE MANIFOLD



IP 2.0 CTM	24.00	2.0" CROSS TEE MANIFOLD
------------	-------	-------------------------

4 = 2" FPT ports in cross pattern.

Can be mounted on pod skid base (sold separately).

Ideally suited for above ground sub-main that can be moved around the field.

Attach 1.75" Irripod tubing, cam lock fittings, ball valves, or a combination to suit your application.

Base not included.
Shown for
illustration only.



IP-HMTD Hitch Mount Tube Dispenser



<u>PART #</u>	<u>LIST</u>	<u>DESCRIPTION</u>
IP HMTD	call	Hitch Mount Tube Dispenser

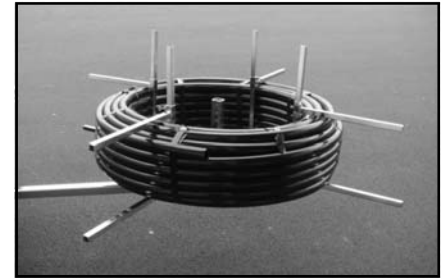

The Hitch Mount Tube Dispenser (HMTD) has been designed to help install Irripod tubing faster and easier. It is fully adjustable, easy to take apart for transport and storage, and plated for long service life.

Can also be used with drip tube if the coils will fit:

Dimensions are approximate:

Coil minimum I.D. = 16"

Coil maximum O.D. = 72"

Coil maximum height = 22"



UNIVERSAL SALES ~ Irripod

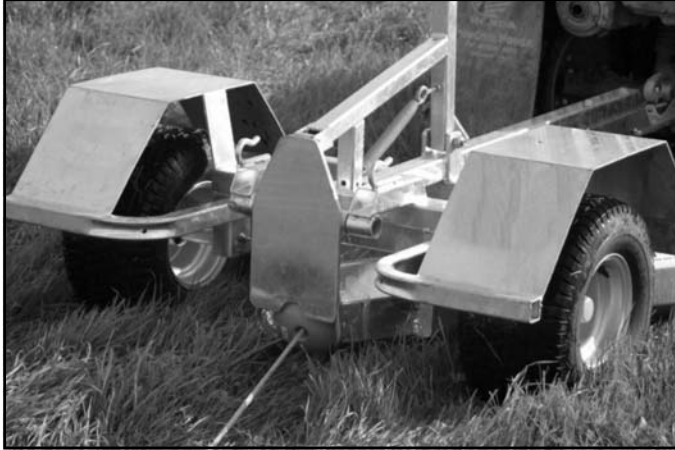

	PART #	LIST	DESCRIPTION
TOW TRAILER & BALL			



IP TT	call for quote	TOW TRAILER
IP TB	29.00	TOW BALL

With the Irripod tow trailer, Irripod lines can be shifted without getting off/out of the vehicle:

- 1) Connect tow balls to each tow rope on the end of each Irripod line.
- 2) Drive the trailer over the tow ball and the trailer will automatically catch the ball.
- 3) Shift the Irripod line to the next location.
- 4) Release the tow ball from the trailer by pulling on the release mechanism.

FENCE SIGNS

1	IP FS SET	159.60	14 NUMBERED FENCE SIGNS #1 to #14
14	Use fence signs to mark each Irripod shift position.		



UNIVERSAL SALES ~ Irripod

Friction Loss Charts:

1.5"

Standard Friction Loss Characteristics 1.5" Inside Diameter Polyethylene Pipe version: 3-1-08		
Flow GPM	Head loss psi/100'	Velocity ft/sec
1	0.01	0.18
2	0.02	0.36
3	0.05	0.54
4	0.08	0.72
5	0.12	0.91
6	0.16	1.09
7	0.22	1.27
8	0.28	1.45
9	0.35	1.63
10	0.42	1.81
11	0.50	1.99
12	0.59	2.17
14	0.79	2.54
16	1.01	2.90
18	1.25	3.26
20	1.52	3.62
22	1.81	3.99
24	2.13	4.35
26	2.47	4.71
28	2.83	5.07
30	3.22	5.44
35	4.28	6.34
40	5.49	7.25
Friction loss calculated using Hazen-Williams formula and a smoothness constant of 150.		
This information is estimated using formulas - actual field conditions may vary.		
Low Density Polyethylene	Temperature	Pressure
	Degrees Fahrenheit	Rating PSI
1.5" ID x 1.75" OD	70	90
	80	84
	90	77
	100	70
	110	62
	120	54
Pressure ratings are estimated typical values only and are not guaranteed.		

1.75"

Standard Friction Loss Characteristics 1.75" Inside Diameter Polyethylene Pipe version: 3-1-08		
Flow GPM	Head loss psi/100'	Velocity ft/sec
1	0.00	0.13
2	0.01	0.27
3	0.02	0.40
4	0.04	0.53
5	0.06	0.67
6	0.08	0.80
7	0.10	0.93
8	0.13	1.07
9	0.16	1.20
10	0.20	1.33
11	0.24	1.46
12	0.28	1.60
14	0.37	1.86
16	0.47	2.13
18	0.59	2.40
20	0.72	2.66
22	0.86	2.93
24	1.01	3.20
26	1.17	3.46
28	1.34	3.73
30	1.52	3.99
35	2.02	4.66
40	2.59	5.33
45	3.22	5.99
50	3.92	6.66
55	4.67	7.32
Friction loss calculated using Hazen-Williams formula and a smoothness constant of 150.		
This information is estimated using formulas - actual field conditions may vary.		
Low Density Polyethylene	Temperature	Pressure
	Degrees Fahrenheit	Rating PSI
1.75" ID x 2.0" OD	70	80
	80	76
	90	70
	100	62
	110	56
	120	50
Pressure ratings are estimated typical values only and are not guaranteed.		



UNIVERSAL SALES ~ Irripod

Rotator and Sprinkler Performance:



Nelson Irrigation								
R2000LP Low Pressure Wind Fighter Rotator								
Performance Chart								
Plate	Nozzle	Radius	GPM at Stated PSI					
			25	30	35	40	45	50
12 purple	10 blue	34' to 37'	0.88	0.97	1.05	1.12	1.19	1.25
	11 orange		1.07	1.17	1.27	1.36	1.45	1.53
	12 purple		1.27	1.39	1.50	1.61	1.70	1.80
14 green	13 yellow	39' to 41'	1.50	1.64	1.78	1.90	2.02	2.13
	14 green		1.70	1.85	2.00	2.15	2.28	2.40
16 red	15 tan	40' to 42'	1.98	2.17	2.35	2.53	2.67	2.82
	16 red		2.28	2.50	2.70	2.89	3.07	3.23
18 gold	18 gold	41' to 43'	2.92	3.20	3.44	3.68	3.89	4.11
20 brown	20 brown	42' to 45'	3.56	3.90	4.18	4.48	4.76	5.00



Senninger Irrigation						
3023 Series 3/4" Impact						
Performance Chart						
Nozzle		PSI				
		30	35	40	45	50
7/64"	GPM	1.84	1.99	2.12	2.25	2.37
	Diam Ft	80	82	84	86	87
1/8"	GPM	2.42	2.62	2.79	2.97	3.12
	Diam Ft	83	85	86	87	88
9/64"	GPM	3.08	3.33	3.56	3.78	3.98
	Diam Ft	85	87	88	90	91
5/32"	GPM	3.82	4.13	4.41	4.68	4.93
	Diam Ft	87	89	90	91	92

For other sprinklers and more information visit our website: www.universalsales.biz

Design information for reference only. Actual performance may vary depending on real life conditions in the field. While every effort has been made to ensure accuracy in regards to information contained in this publication, neither Universal Sales, Irripod, Nelson, Senninger, nor any employees of these companies, shall be liable on any grounds whatsoever to any party in respect of decisions or actions they may make as a result of using this information. These companies reserve the right to make changes without notice to any service or product specification.





UNIVERSAL SALES

Irripod Flexible Irrigation

www.universalsales.biz ~ PH (541) 998-9999 ~ FX (541) 998-9998

TERMS AND CONDITIONS

TERMS:

Net 10th of month following the invoice date. A 1 1/2% per month service charge will be added to all past due accounts.

MINIMUM ORDER:

There is no minimum invoice amount, however a \$5.00 service charge will be added to invoices under \$50.00. This does not apply to backorders.

CREDIT:

Credit approval for an open account and discount eligibility must be established prior to initial order. COD may be requested for accounts with credit applications in process. Shipments will be held on established accounts with an unsatisfactory payment status.

PRICES:

We reserve the right to change prices without notice. However, we will endeavor to announce price changes 30 days prior to the date of effectiveness. Unless noted otherwise on our sales acknowledgment, prices are those in effect at time of shipment.

SHORTAGES:

All claims such as pricing, shortages, returns, etc. must be made within 10 days from receipt of shipment in writing. All shortages should be identified by giving us the invoice number and date on which merchandise was invoiced. No debit memo will be accepted until final disposition is determined and factory credit memo is issued.

PRODUCT DESIGN:

Manufacturer reserves the right to redesign, alter, or modify its products without incurring liability for customer's inventory or future compatibility.

DEFECTIVE MATERIALS:

Contact sales office for field inspection prior to any disposition of material. No debit memos, freight charges, returns, etc. will be honored without corporate authorization.

MERCHANDISE RETURNED FOR CREDIT:

No merchandise will be accepted without prior approval of the nearest Universal Sales warehouse. All materials approved for return shall be returned freight prepaid and are subject to a 20% restocking charge.



DAMAGED FREIGHT:

Products are packaged and accepted by the freight forwarder in undamaged condition. Do not sign for damaged freight without noting damages on the waybill. Notify Universal Sales headquarters immediately for instructions on how to proceed.